

HỆ KHUNG TRẦN CHÌM Concealed Ceiling System

MONO KHUNG TRẦN CHÌM PHỔ THÔNG Standard Concealed Ceiling System



PARA KHUNG TRẦN CHÌM CAO CẤP Advanced Concealed Ceiling System



GAMMA KHUNG TRẦN CHÌM CAO CẤP Advanced Concealed Ceiling System

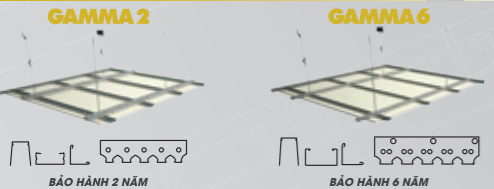

SUPER KHUNG TRẦN CHÌM CAO CẤP Advanced Concealed Ceiling System

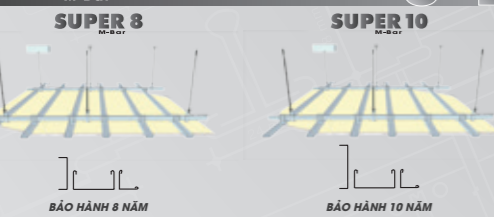

HỆ KHUNG TRẦN NỔI Exposed Ceiling System

ALPHA KHUNG TRẦN NỔI Exposed Ceiling System

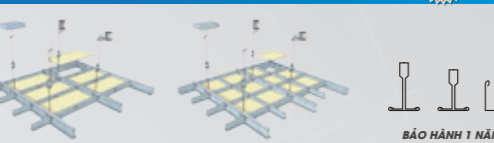

MEGA KHUNG TRẦN NỔI Mega Exposed Ceiling System



OMEGA KHUNG TRẦN NỔI SỌC ĐEN Iee System with Black Reveal



HỆ KHUNG VÁCH Drywall System

PARTI KHUNG VÁCH NGĂN PHỔ THÔNG Standard Drywall System

PARTI 64 - 76
Độ dày: 0.42 (mm)
Thickness: 0.42 (mm)



PARTI⁺ KHUNG VÁCH NGĂN CAO CẤP Advanced Drywall System

PARTI PLUS 64 - 76 - 92 - 102
Độ dày: 0.50 (mm)
Thickness: 0.50 (mm)



PARTI^{MAX} KHUNG VÁCH NGĂN CAO CẤP Advanced Drywall System

PARTI MAX 64 - 76 - 92 - 102 - 127 - 152
Độ dày: 0.75 / 1.00 / 1.15 (mm)
Thickness: 0.75 / 1.00 / 1.15 (mm)



TẤM TRẦN Ceiling Board

GYP ART TẤM THẠCH CAO MỸ THUẬT GypArt Board



DOMINO TRẦN KIM LOẠI Metal Ceiling



PHỤ KIỆN AAA Accessories

AAA CỬA THẨM TRẦN Access Panel

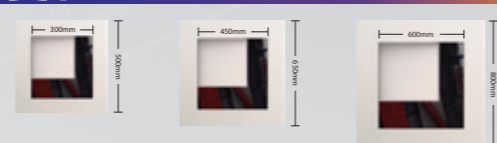

AAA BĂNG KEO LƯỚI Fiberglass Tape



AAA BĂNG KEO GIẤY Paper Tape



NHÀ MÁY SẢN XUẤT KHUNG TRẦN VÀ KHUNG VÁCH MANUFACTURER OF CEILING AND DRYWALL STEEL FRAME



NEW



ALPHA KHUNG TRẦN NỔI Exposed Ceiling System

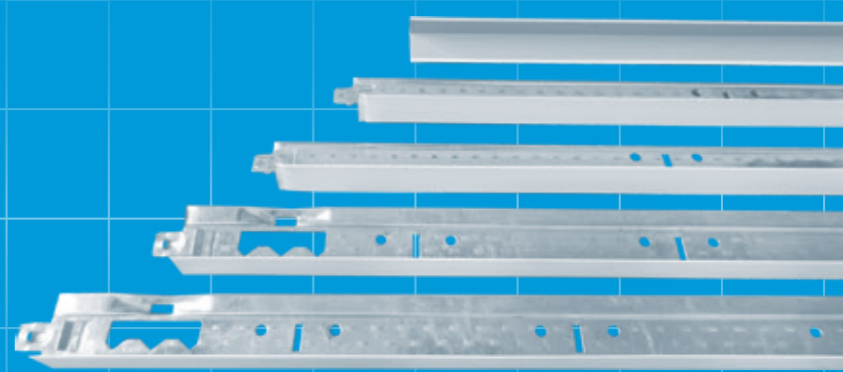

D & S CORPORATION
CÔNG TY CỔ PHẦN D&S

Chất Lượng
& AN TOÀN
Quality and Safety

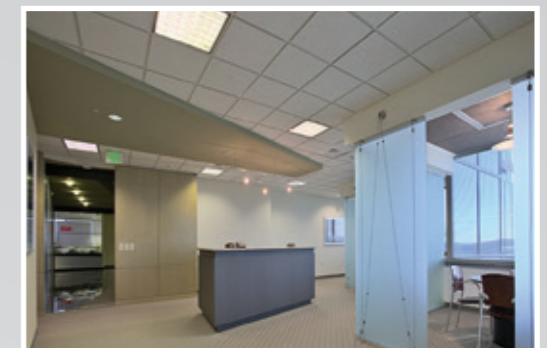

CHI TIẾT KỸ THUẬT / DETAIL

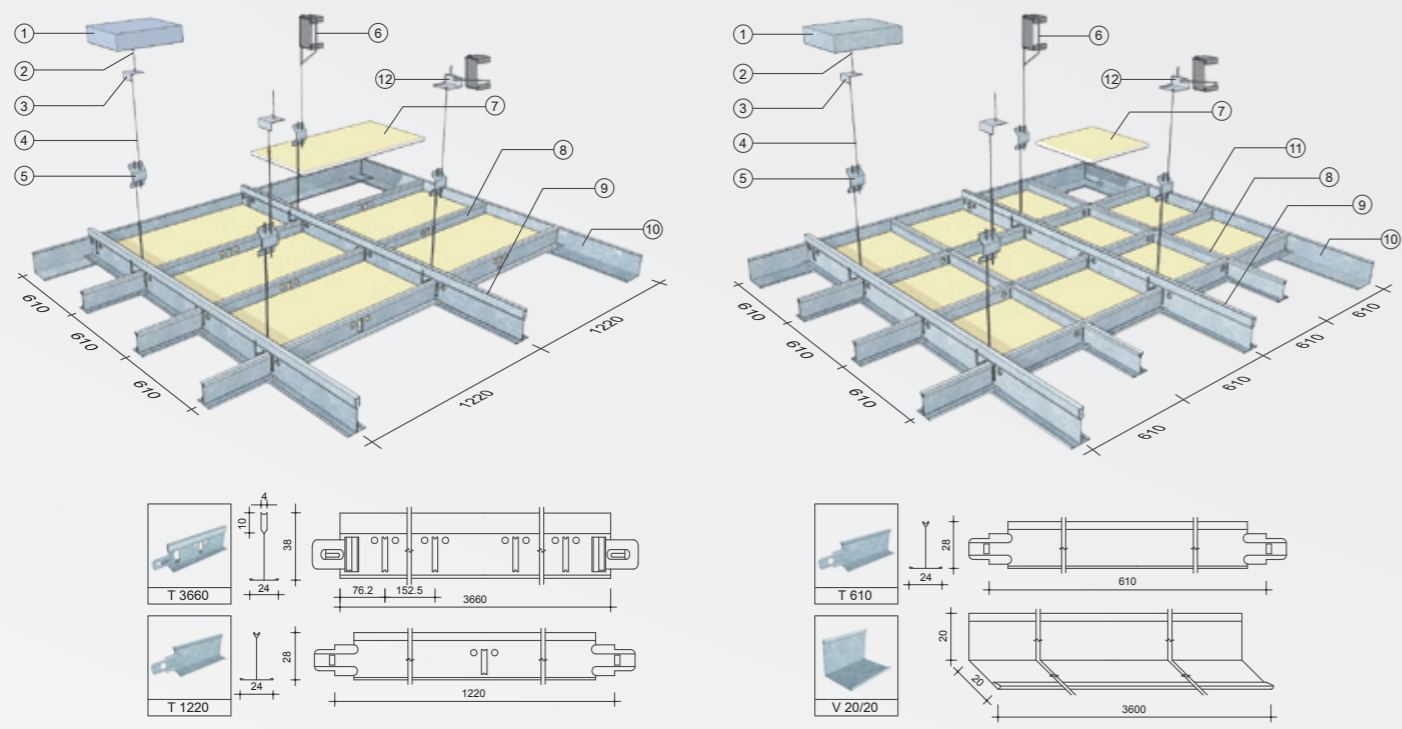

GHI CHÚ / NOTE

- ① Sàn bê tông
Concrete Soffit
- ② Tắc kê Ø8mm: **PK-TK1**
Expansion Bolt Ø8mm: **PK-TK1**
- ③ Pát 2 lỗ: **PK-P1**
Bracket Angle: **PK-P1**
- ④ Ty Treo Ø4mm: **PK-T4**
Suspension Rod Ø4mm: **PK-T4**
- ⑤ Tầng đờ 4 lỗ: **PK-TD4**
Suspension Clip: **PK-TD4**
- ⑥ Bộc ty vào xà gỗ mái tole
Tie suspension rod to beam of metal roof
- ⑦ Tấm trần
Ceiling Tiles
- ⑧ Thanh phụ dài: **ALPHA T1220**
Long Cross T: **ALPHA T1220**
- ⑨ Thanh chính: **ALPHA T3660**
Main T: **ALPHA T3660**
- ⑩ Thanh góc: **ALPHA V3600**
Wall Angle: **ALPHA V3600**
- ⑪ Thanh phụ ngắn: **ALPHA T610**
Short Cross T: **ALPHA T610**
- ⑫ Đờ góc liên kết với xà gỗ
Bracket angle connecting with beam

HƯỚNG DẪN LẮP ĐẶT

- Bước 1:** Định vị cao độ trần.
- Bước 2:** Lắp thanh góc theo cao độ trần.
- Bước 3:** Treo ty vào sàn bê tông hoặc xà gỗ với khoảng cách $\leq 1050\text{mm}$ dọc theo thanh chính.
- Bước 4:** Lắp thanh chính vào ty treo.
- Bước 5:** Lắp thanh phụ dài vào thanh chính.
- Bước 6:** Lắp thanh phụ ngắn vào thanh phụ dài.
- Bước 7:** Điều chỉnh phẳng khung trần và lắp tấm.

INSTALLATION GUIDE

- Step 1:** Determine the height of ceiling.
- Step 2:** Install the wall angles at the height of ceiling.
- Step 3:** Hang the suspension rods from the concrete soffit or the purlin, spacing $\leq 1050\text{mm}$ along the main tees.
- Step 4:** Install the main tees connecting with the suspension rods.
- Step 5:** Install the long cross tees connecting with the main tees.
- Step 6:** Install the short cross tees connecting with the long cross tees.
- Step 7:** Adjust the height of ceiling frame and lay in ceiling tiles.